

# Area of Refuge/Two-Way Communication System Mounting Guide





Thank you for purchasing a RATH™ Emergency Communication System. We are the largest Emergency Communication Manufacturer in North America and have been in business for over 35 years.

We take great pride in our products, service, and support. Our Emergency Products are of the highest quality. Our experienced customer support teams are available to remotely assist with site preparation, installation, and maintenance. It is our sincere hope that your experience with us has and will continue to surpass your expectations.

Thank you for your business,

*The RATH™ Team*

## Table of Contents

Call Box Mounting . . . . .	Page 3-8
Base Station Mounting . . . . .	Page 9-14
Distribution Module Mounting . . . . .	Page 15-16
Supervisor Mounting . . . . .	Page 16
Signage Mounting . . . . .	Page 17
System Mounting Diagram . . . . .	Page 18
System Mounting Locations . . . . .	Page 19

# Call Box Mounting

Call Boxes should be mounted so that the push button is 48" from the floor.

## Flush Mount Call Boxes:

2100-958NSR, 2400-808NSP, 2100-958NMBR, 2400-808NMP, SUBPNBX (back box only)

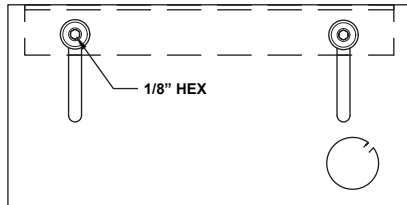

A INTERIOR ELEVATION

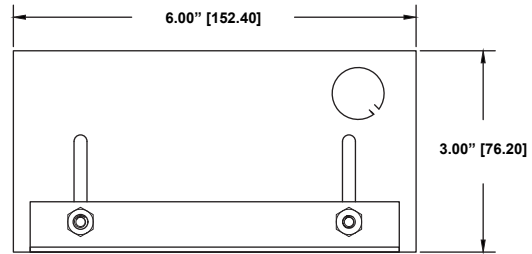

BACK BOX TOP

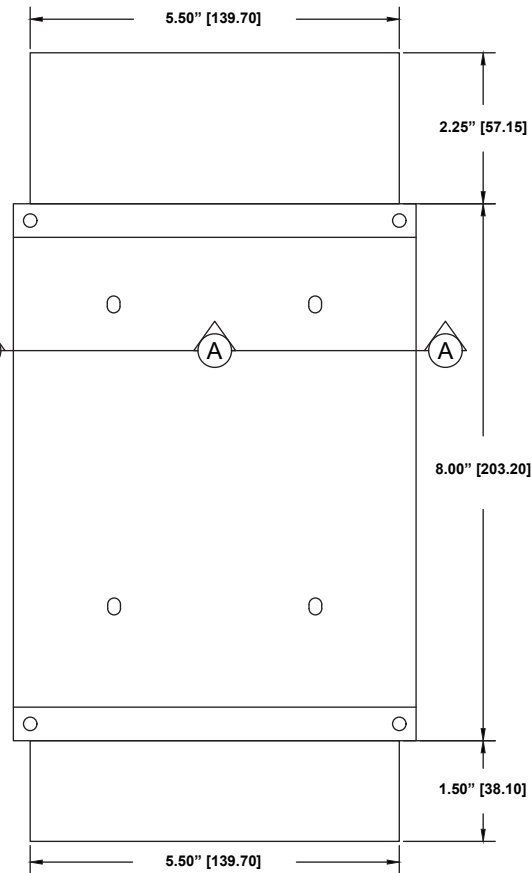

BACK BOX FRONT

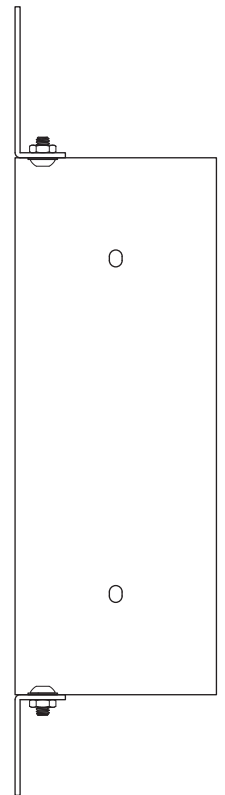

BACK BOX SIDE

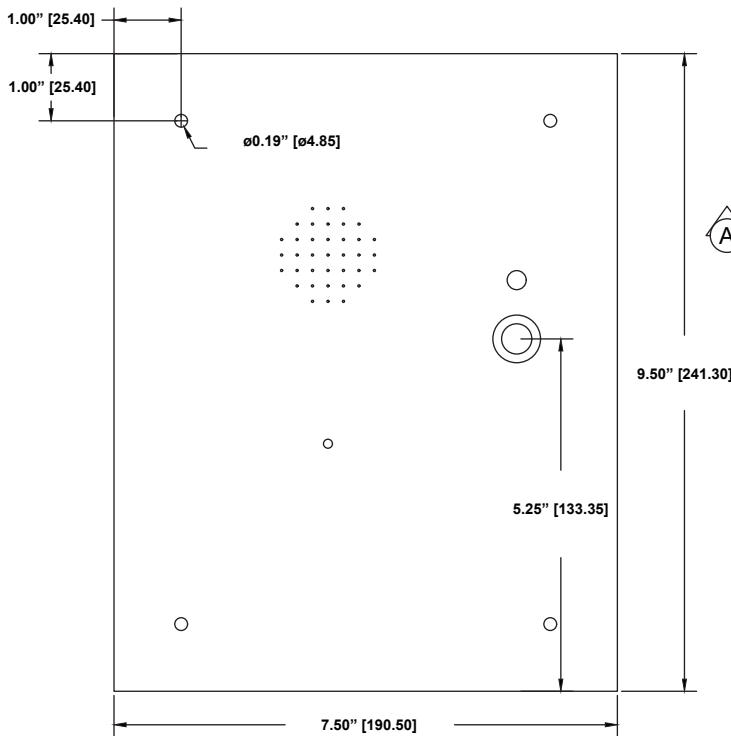

COVER FRONT

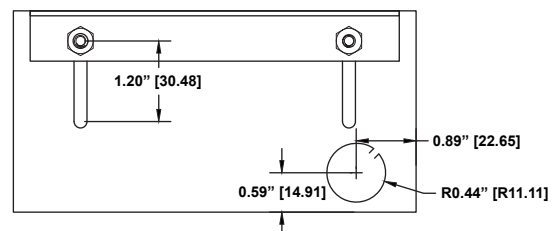

BACK BOX BOTTOM

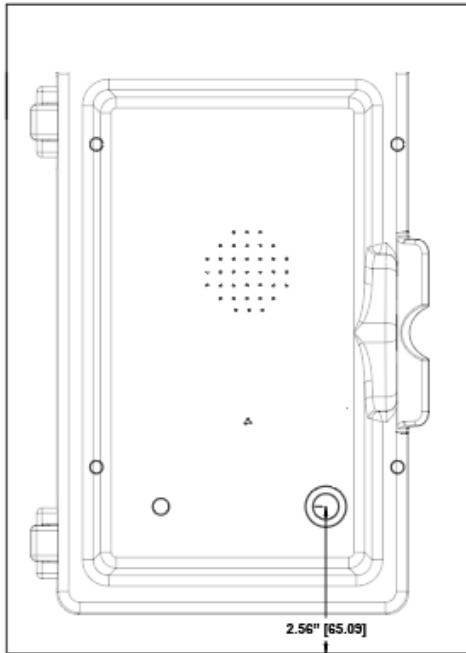

COVER FRONT

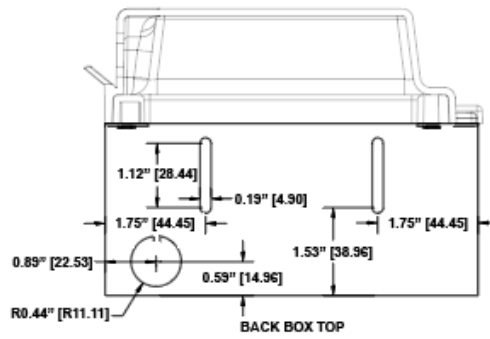

BACK BOX TOP

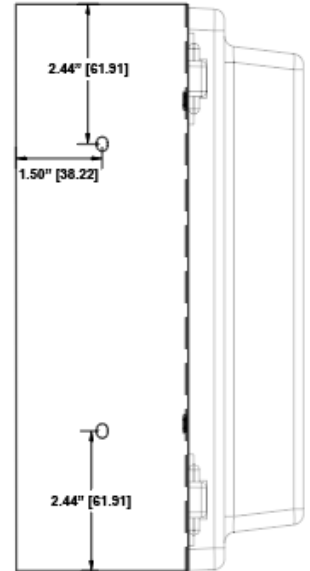

BACK BOX LEFT SIDE

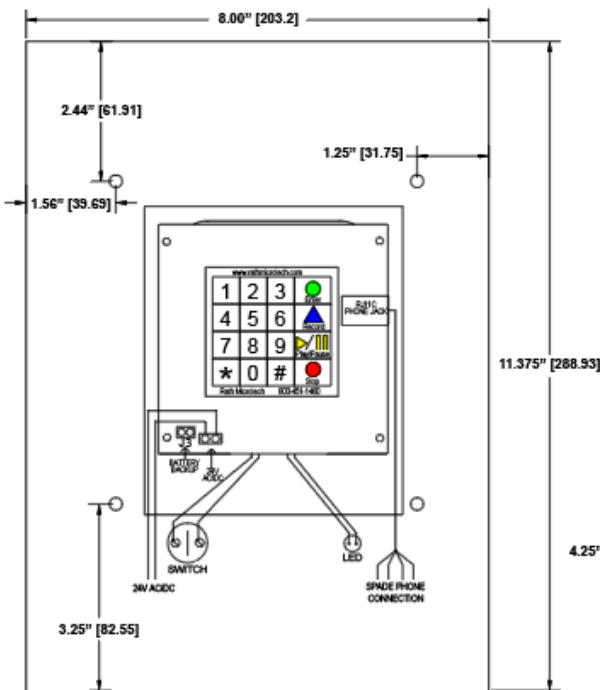

COVER BACK

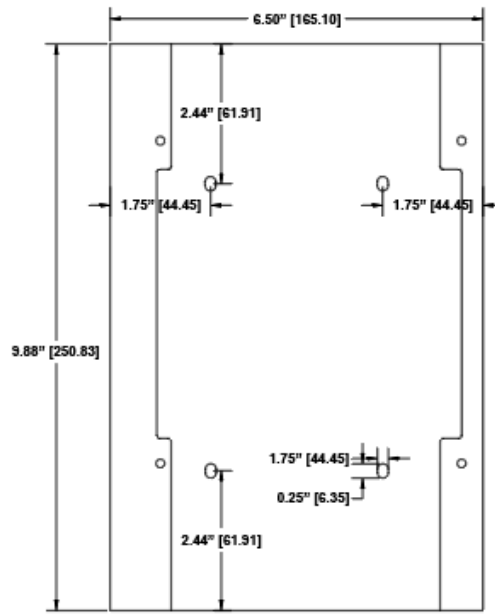

BACK BOX FRONT

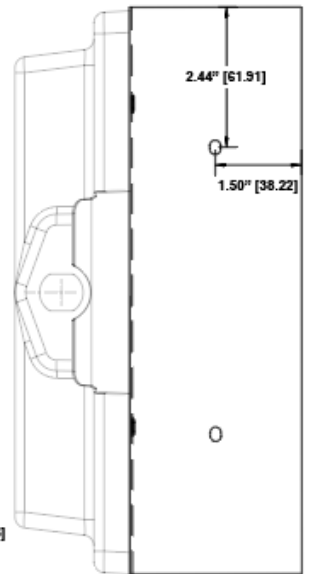

BACK BOX RIGHT SIDE

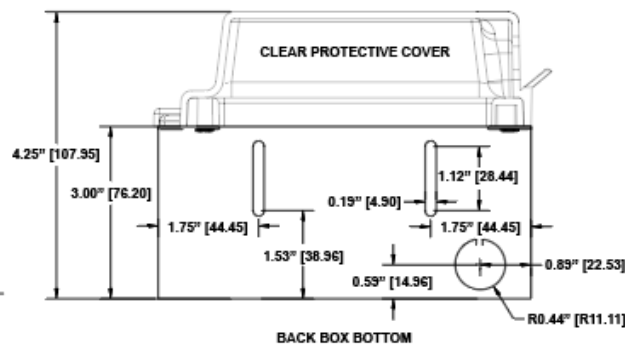

BACK BOX BOTTOM

2100-958SR, SUBPNBX (back box only)

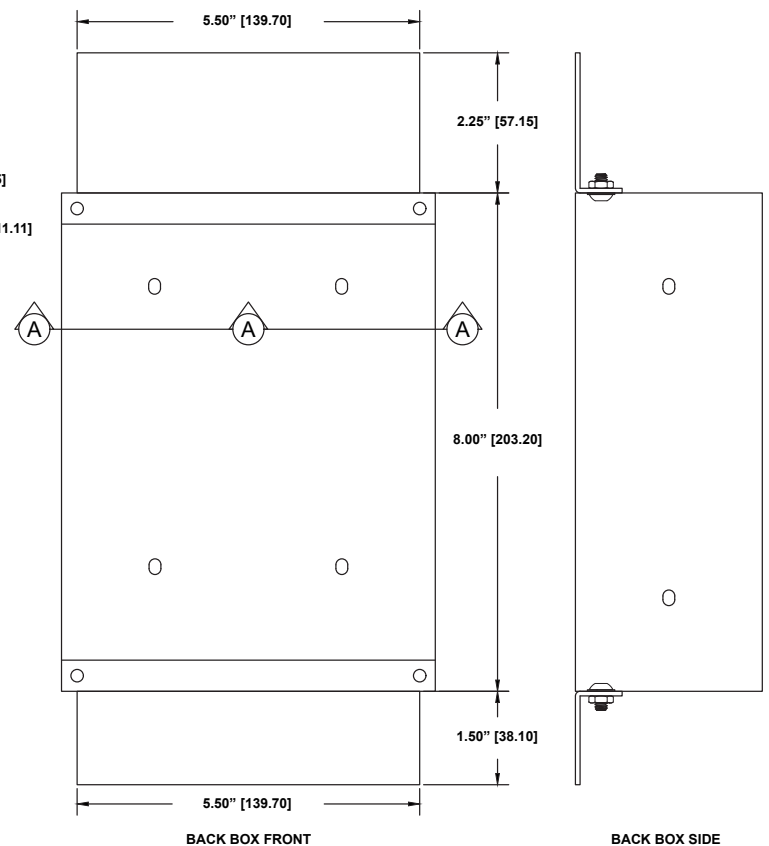
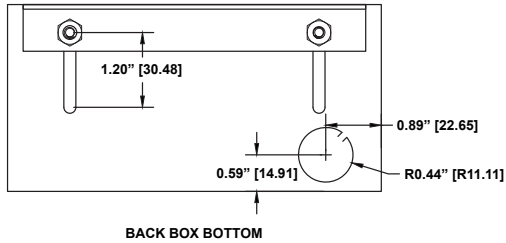
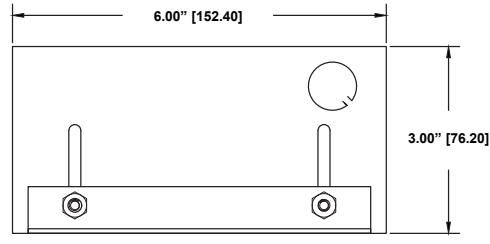
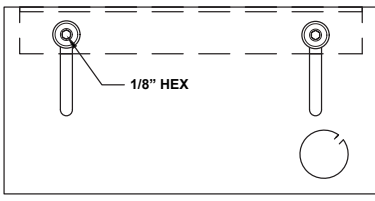
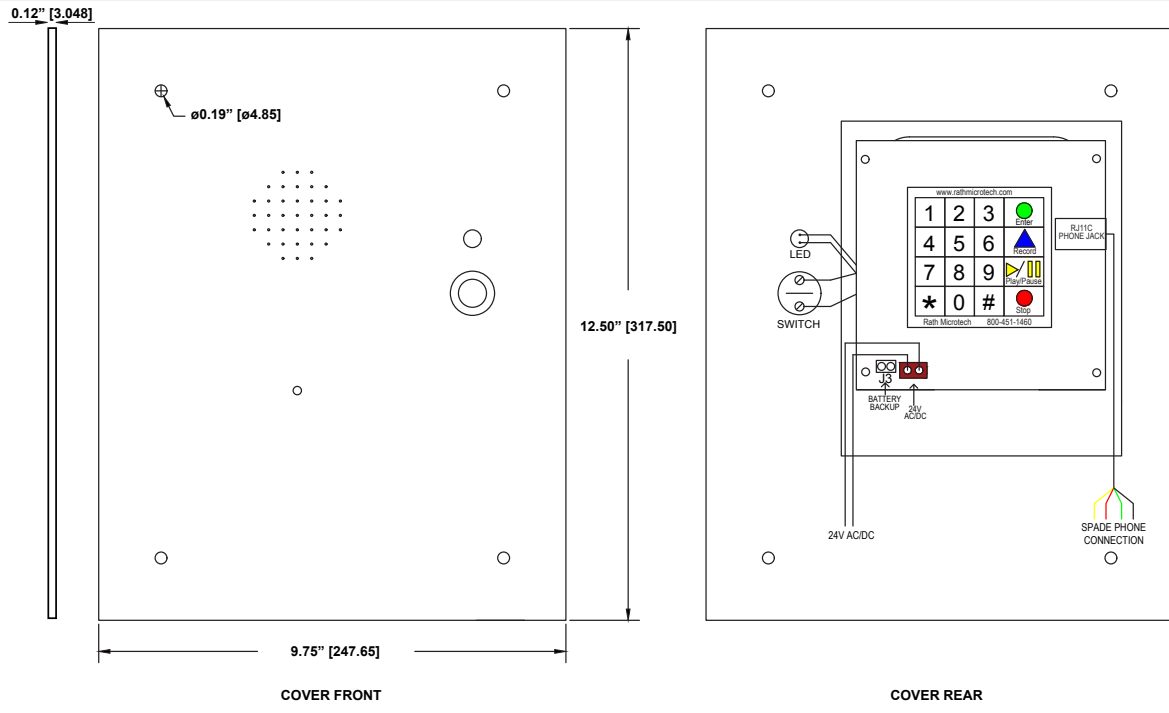

Surface Mount Call Boxes:

2100-956SR, 2400-805SP, 2100-956SRM, 2400-805SPM, 2100-956RR, 2400-805RP

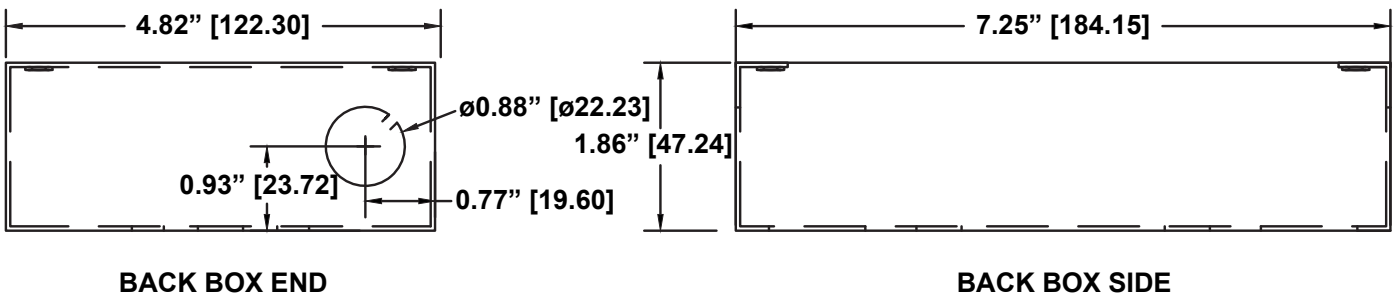
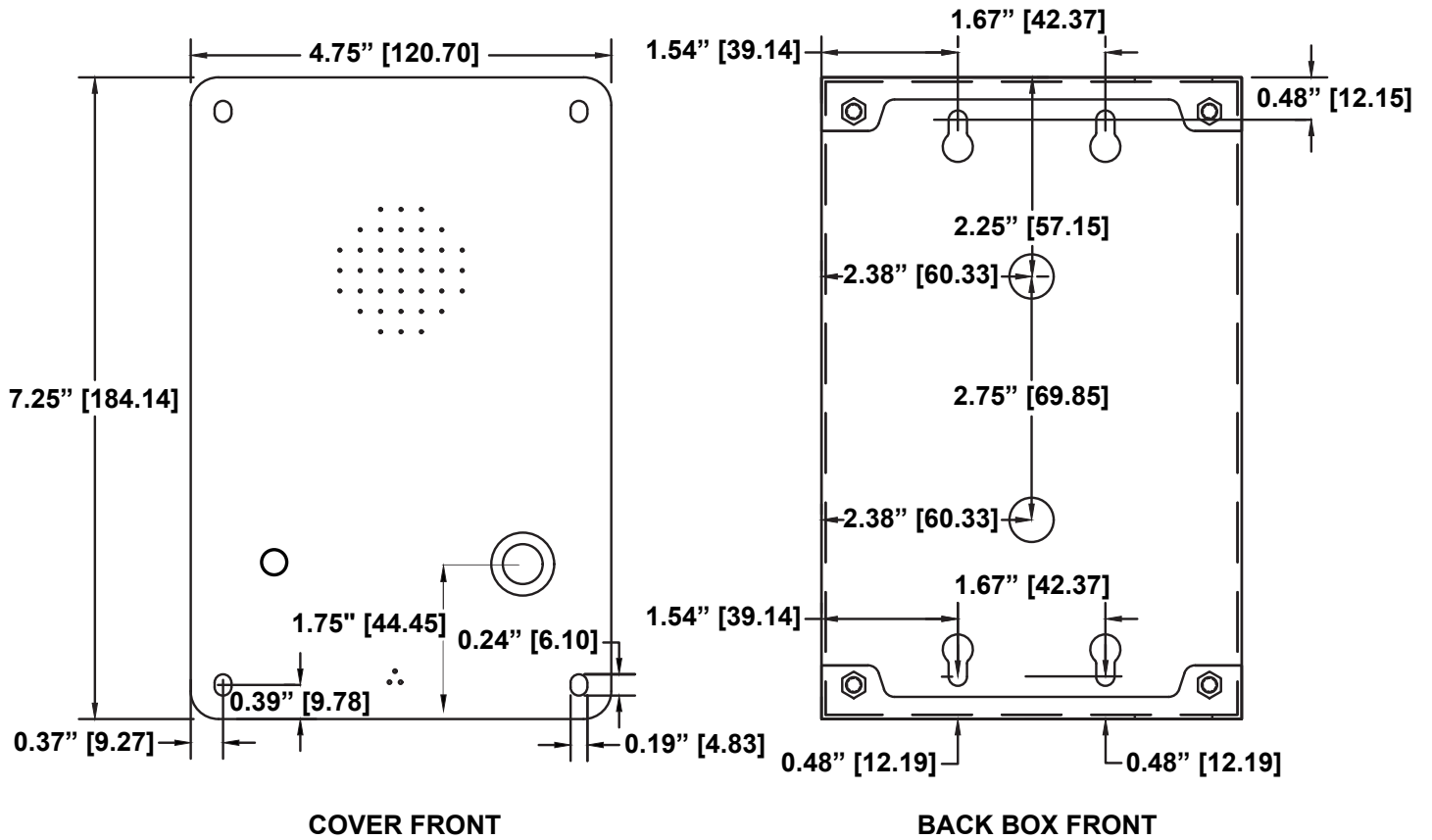

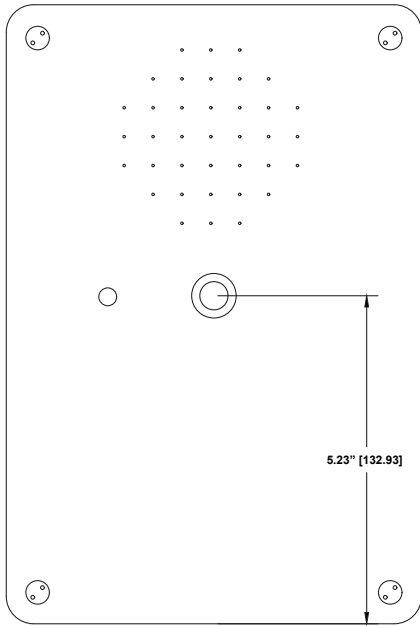

COVER OUTSIDE

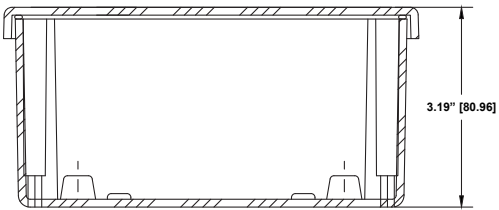

BOTTOM

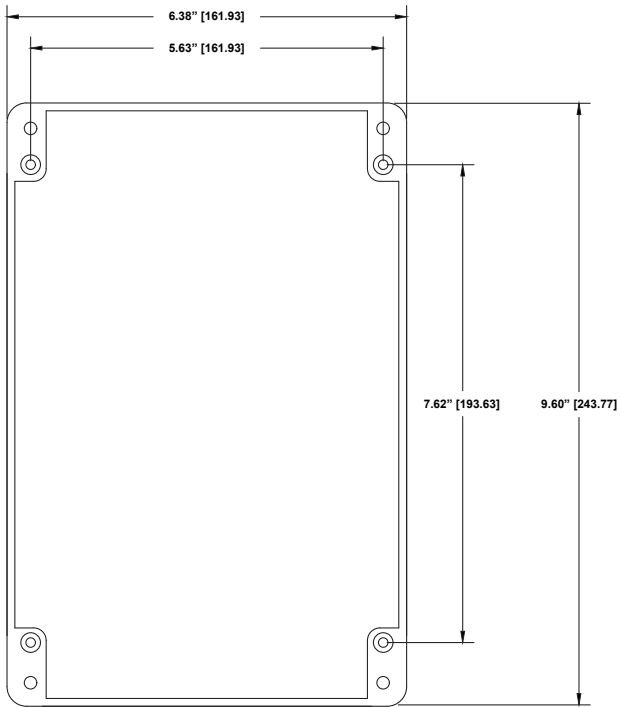

BASE INSIDE

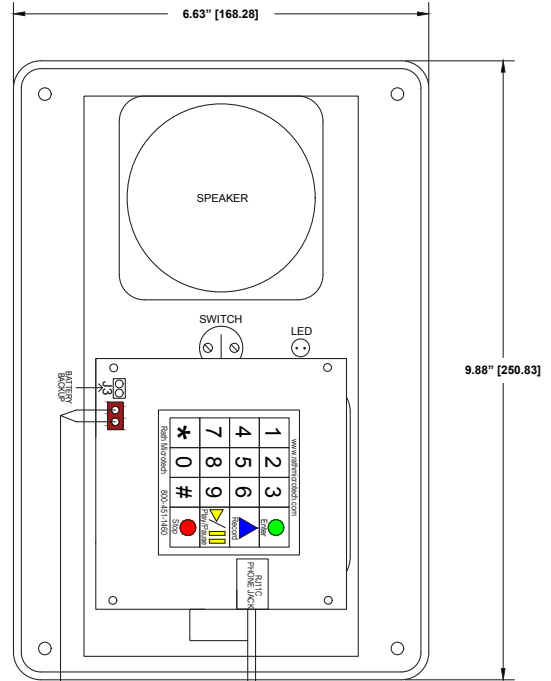

COVER INSIDE

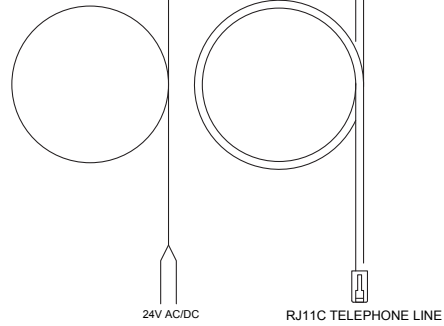

24V AC/DC

RJ11C TELEPHONE LINE

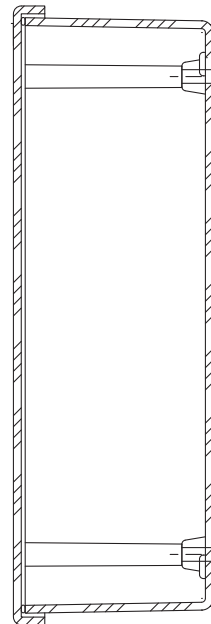

SIDE

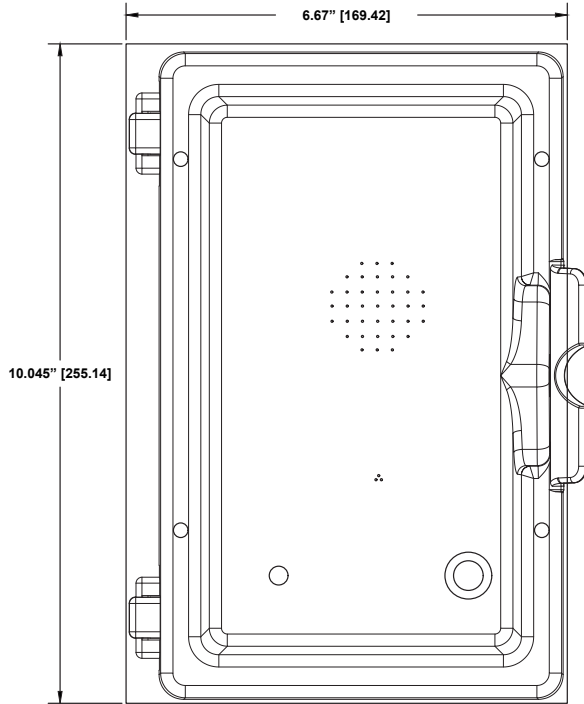

COVER FRONT

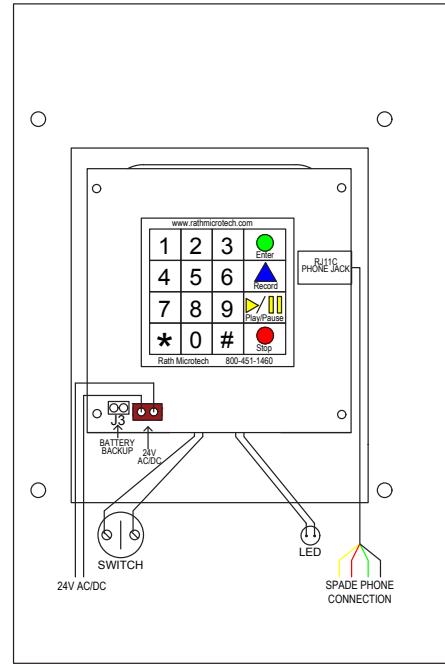

BACK

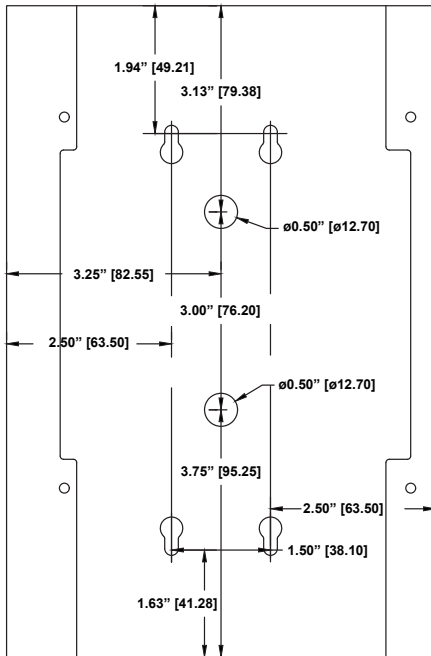

BACK BOX FRONT

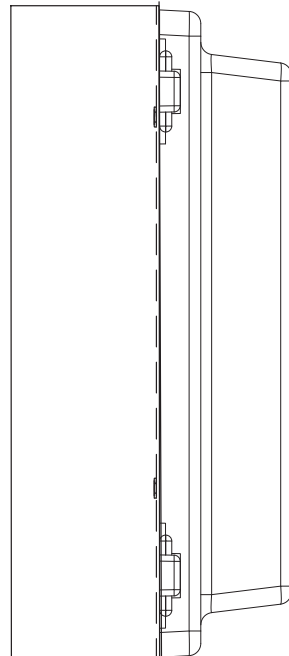

BACK BOX LEFT SIDE

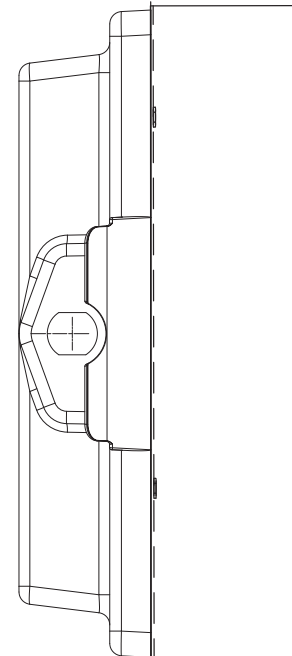

BACK BOX RIGHT SIDE

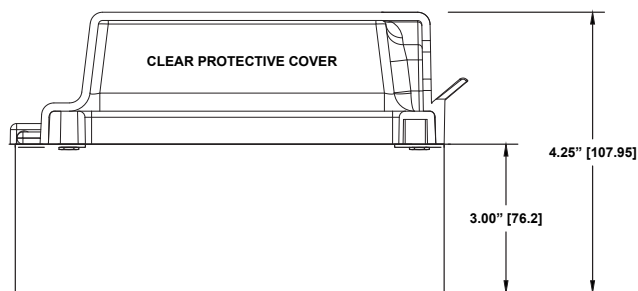

BACK BOX BOTTOM



# Base Station Mounting

RATH™ recommends mounting the Base Station 60" from the floor to the center of the unit.

2500-205D, 2500-210D

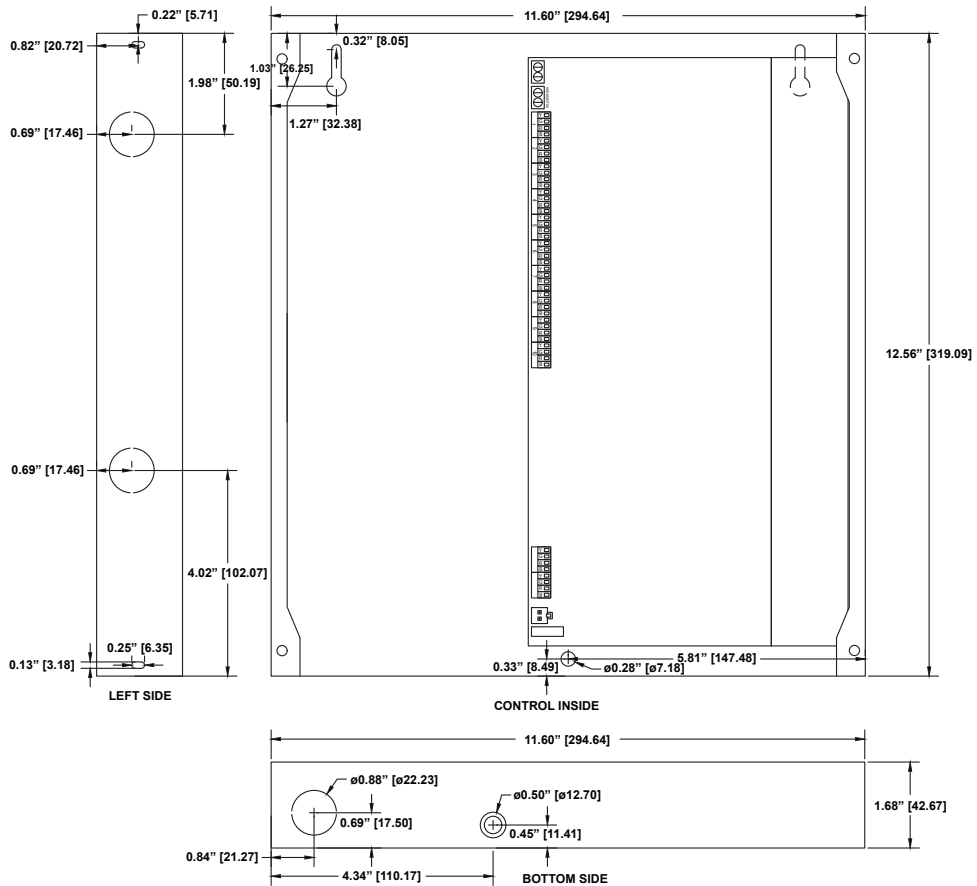
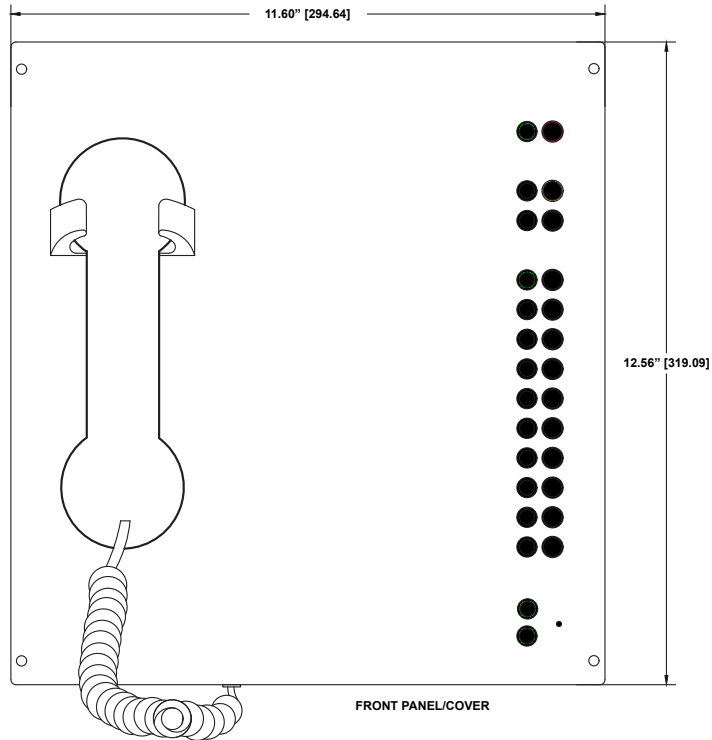

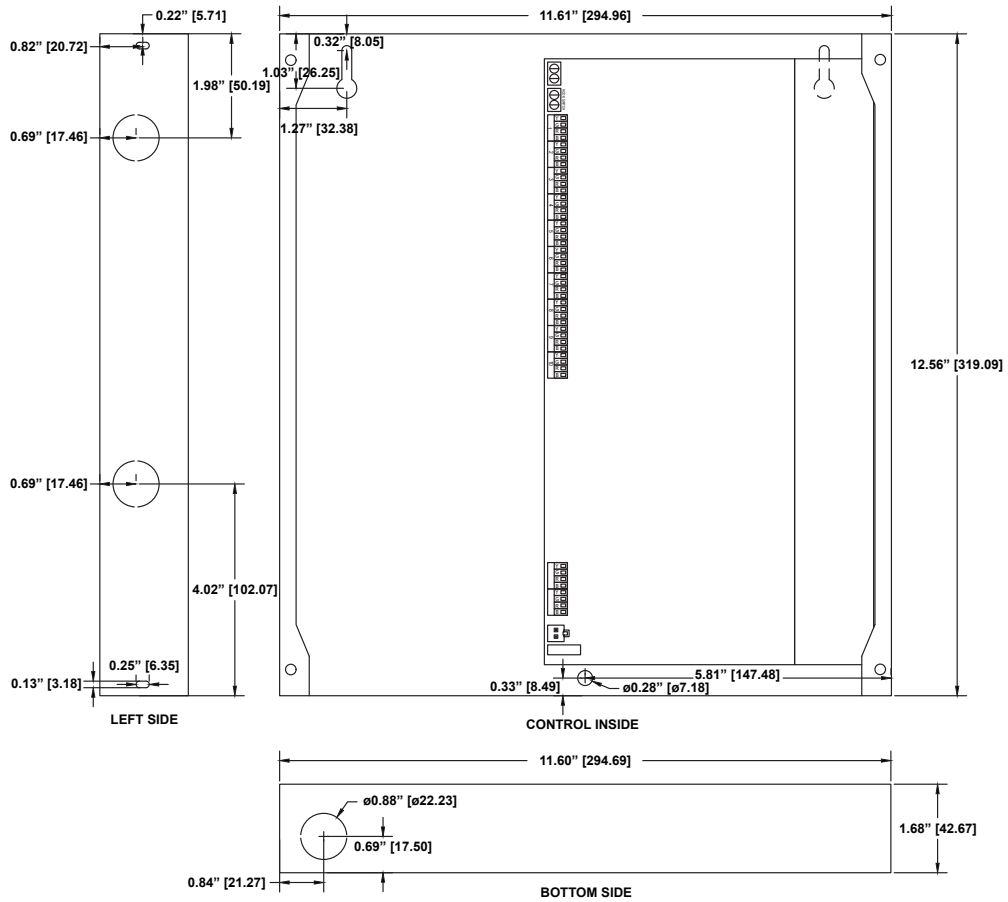
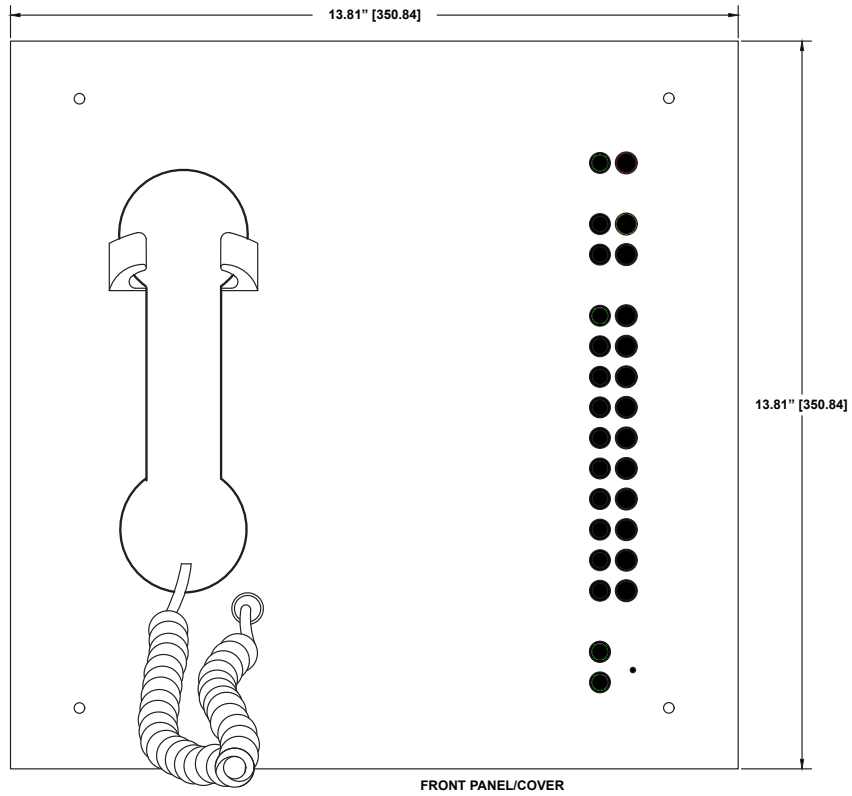

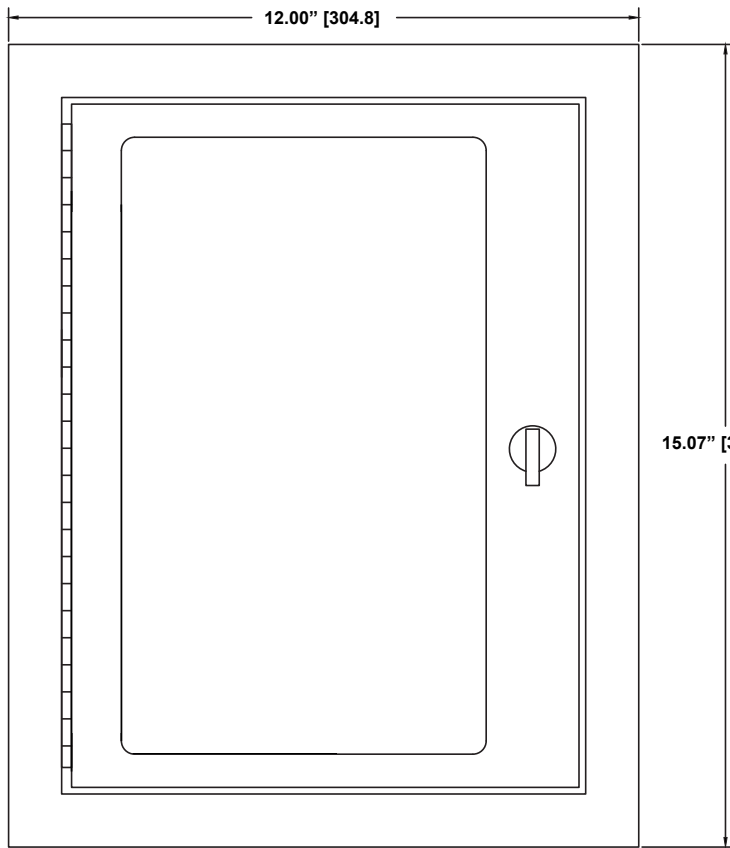

FRONT VIEW

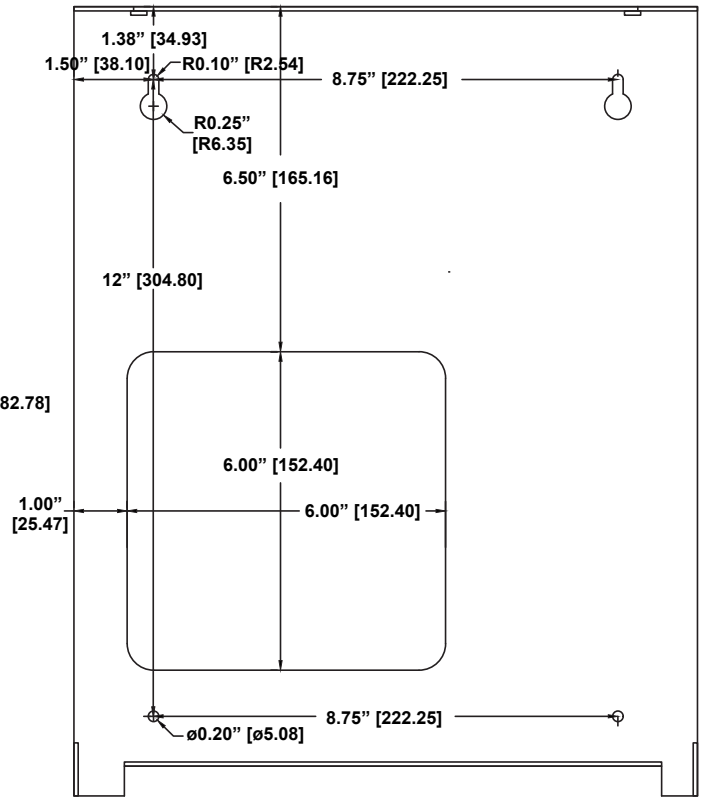

BACK PANEL



BOTTOM VIEW

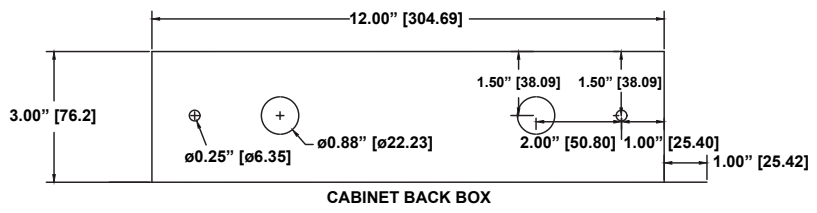
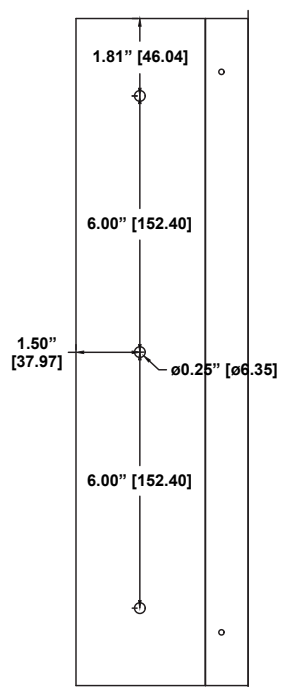
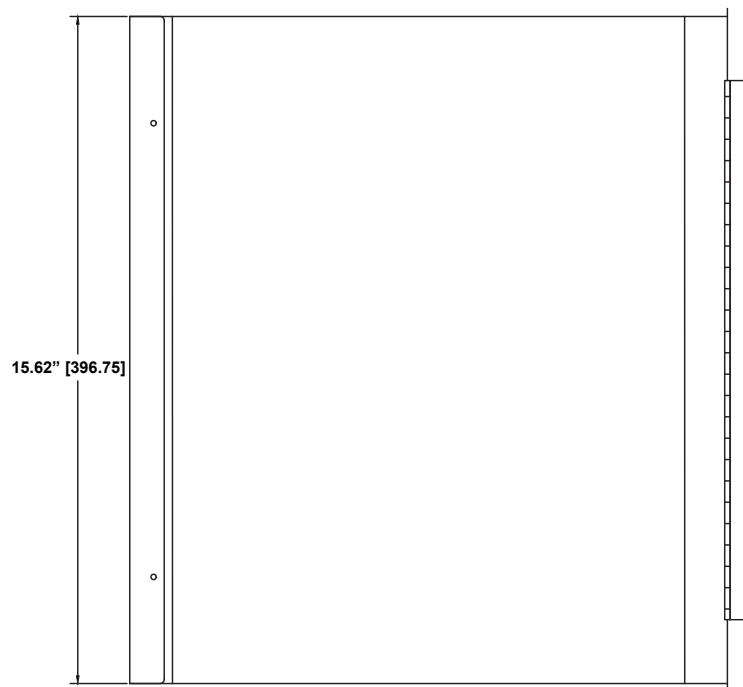
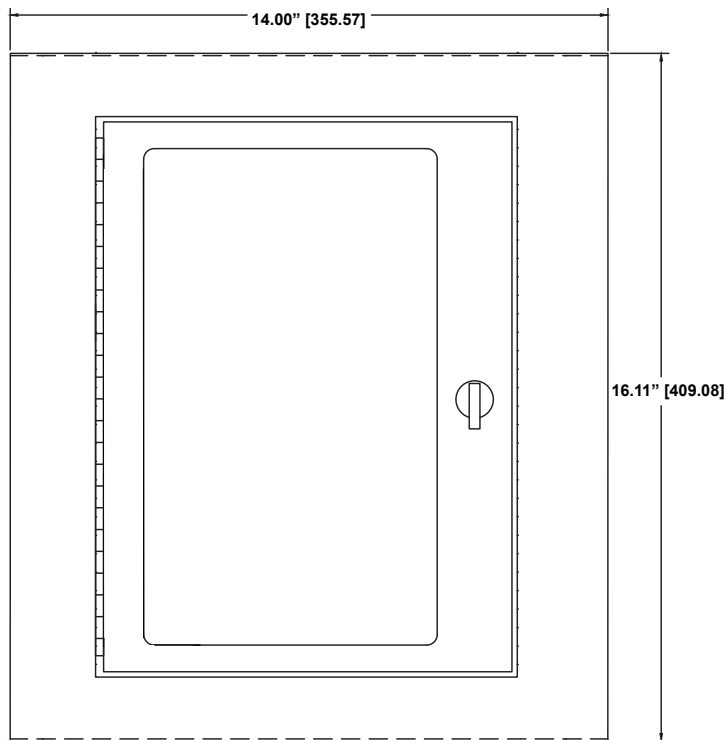

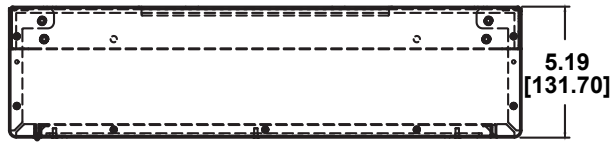

TOP

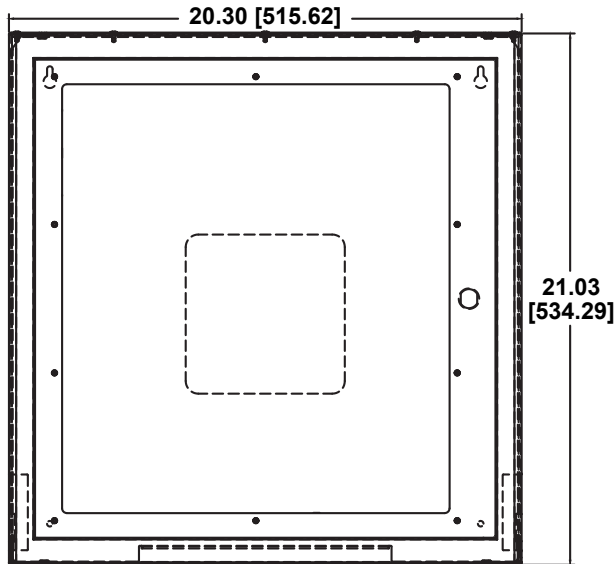

FRONT

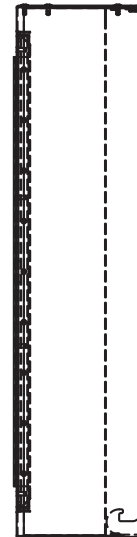

SIDE

CABINET

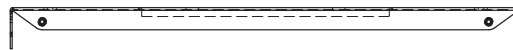

TOP

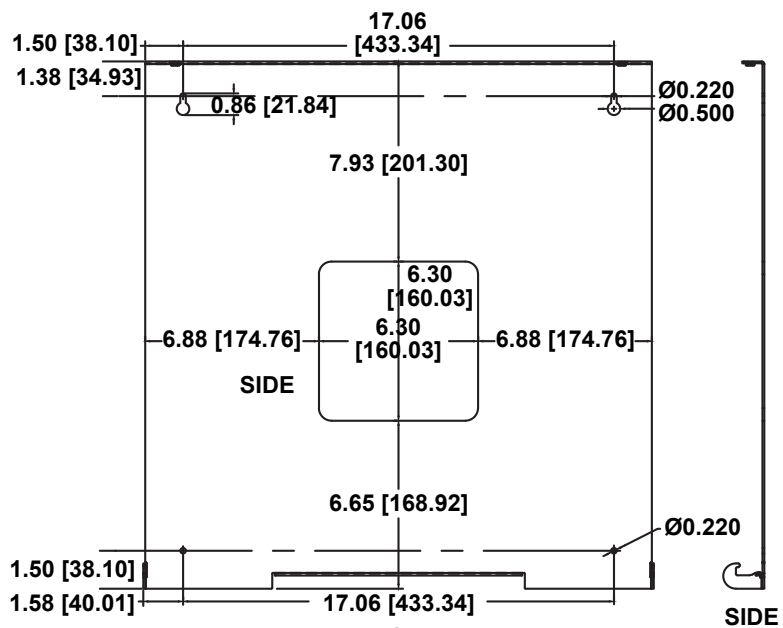

SIDE

FRONT

SIDE

BACK PANEL

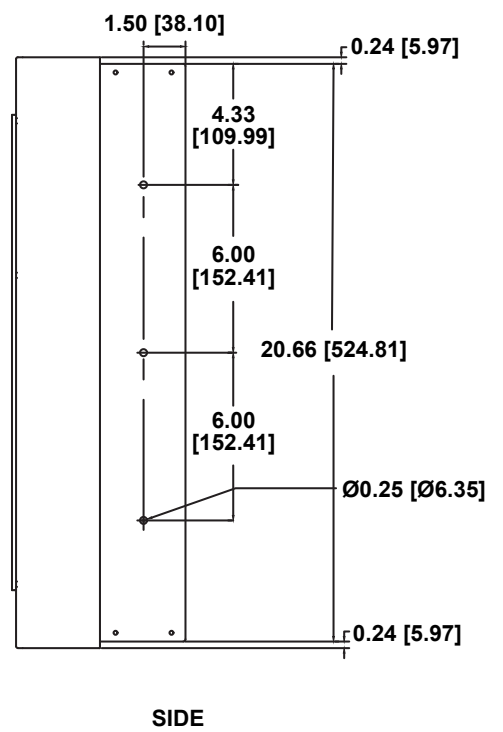
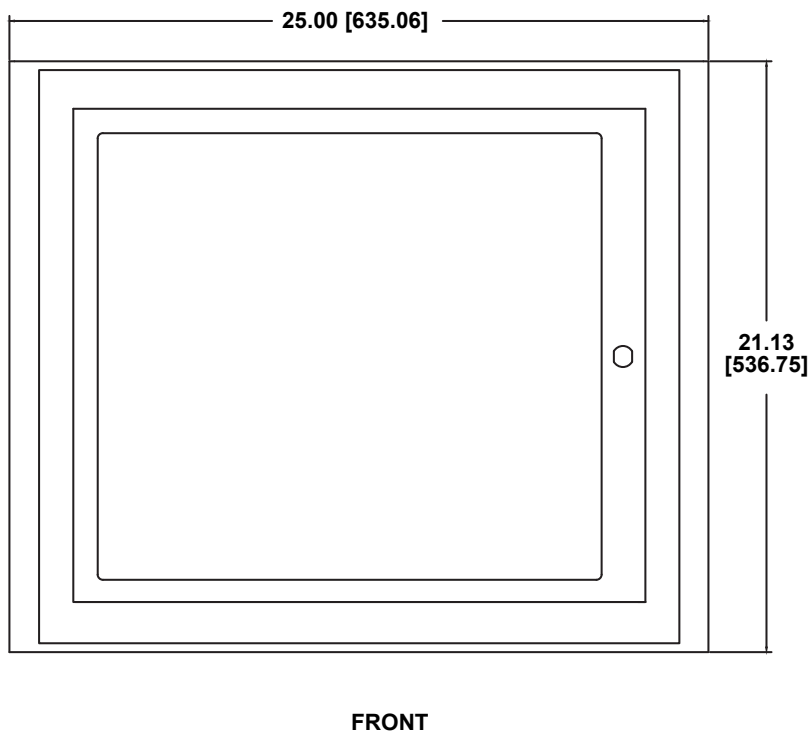
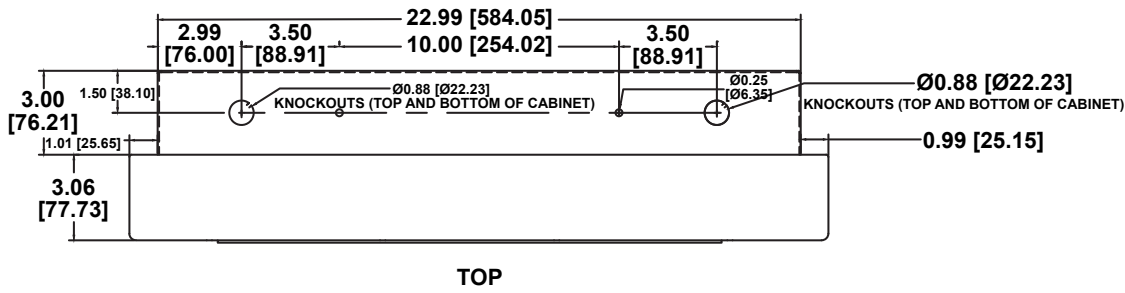

# Distribution Module Mounting (Command System Only)

## 1-36 Zone (PE) Distribution Module

### Option 1: Wall Mounting

- Use diagram as a guide for pre-drilling holes in wall
- Remove top panel and drill out keyholes for mounting
- Secure to wall with provided screws

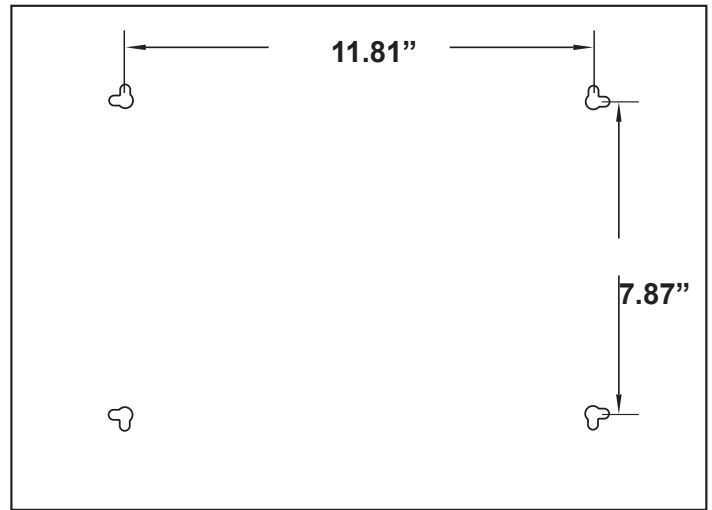

### Option 2: Shelf Mounting (shelf not provided by RATH™)

- Place on shelf mounted in 19" server rack



## 1-116 Zone (GE)

### Option 1: Wall Mounting

- Use diagram below to pre-drill holes into wall
- Secure screws in wall
- Attach Distribution Module to wall using the keyholes on backside

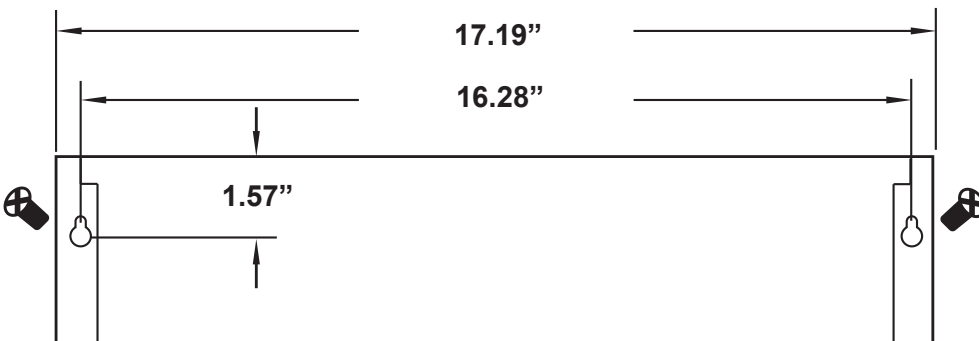

**Option 2: Rack Mounting (rack not provided by RATH™)**

- Attach included brackets to sides of Distribution Module
- Secure to 19" server rack using compatible machine screws for your rack



**Option 3: Shelf Mounting (shelf not provided by RATH™)**

- Place on open rack mounted shelf



## Supervisor Board Mounting (2500-\_\_SPRVSR)

Mount the 2500 Supervisor Board to a wall using the provided swing arm bracket or to a 19" rack (not included).

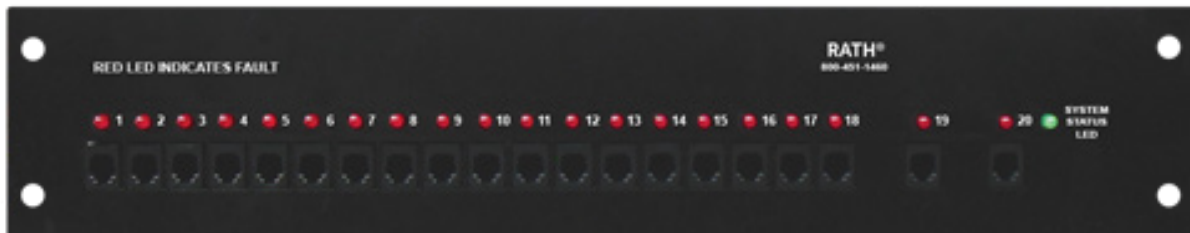



# Signage Mounting

## Instruction Sign

- Mount above or adjacent to each Call Box

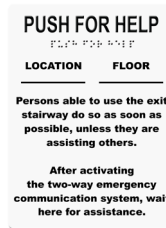

7049

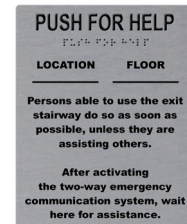

7049SS

## Tactile/Braille Sign

- Mount between 48"-60" from floor to lowest tactile characters



7087



7044

## Illuminated Sign

- 120/277vac powered
- Mount above 60" but below 80" from the floor to top of the sign
- Single gang back box recommended



7050E



7050

## Photo Luminescent

- Mount above 60" but below 80" from the floor to top of the sign



7041E



7041

## Directional Signs

- Mount 48" from the floor to the bottom of the sign
- Located in hallway adjacent to Area of Refuge



7047E



7047

# System Mounting Height Diagram

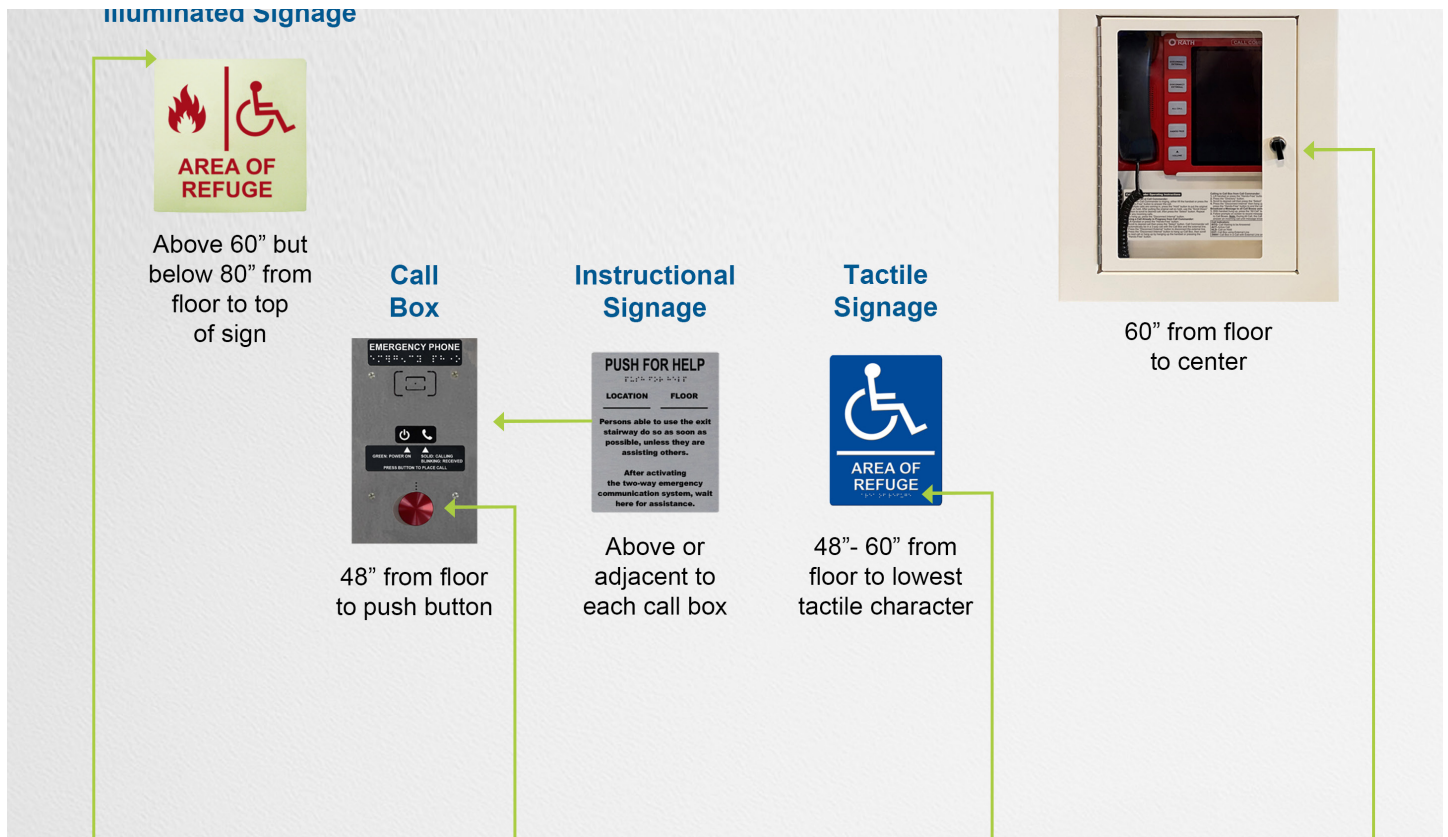

## Call Box:

- 48" from Floor to Push Button

## Lobby or Fire Command Center Base Station

- 60" from Floor to Center

## Signage:

- **Instructional:** Above or Adjacent to each Call Box
- **Tactile:** 48" - 60" from Floor to Lowest Tactile Character
- **Illuminated:** Above 60" but Below 80" from Floor to Top of Sign

# System Mounting Locations

## In Elevator Landings:

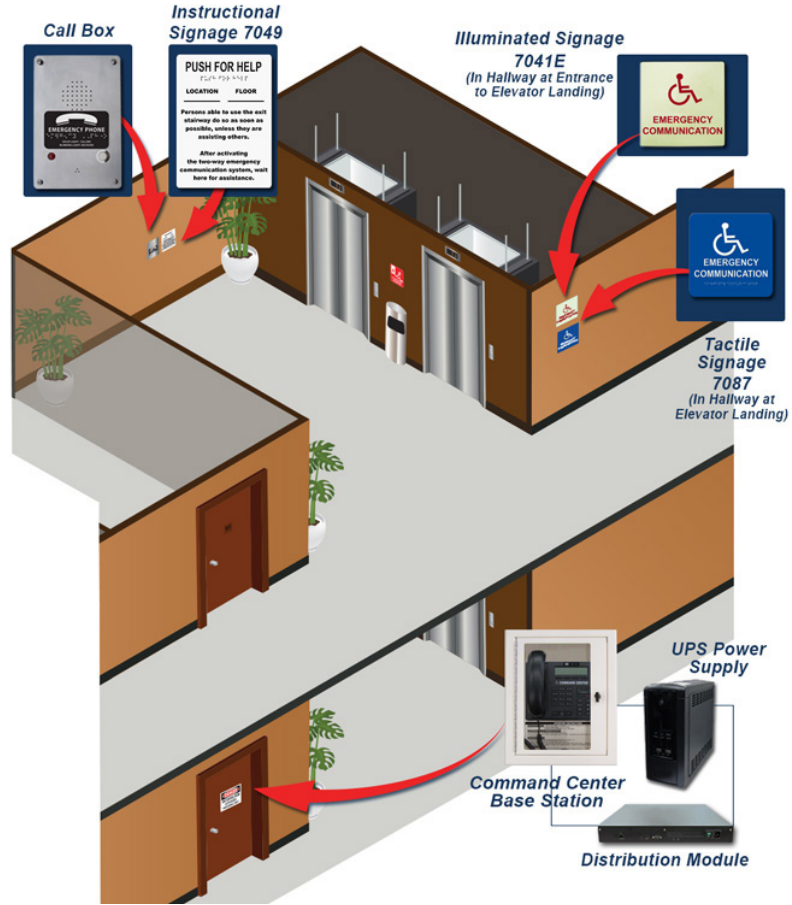

## In Stairwells:

